

附圖一 烏嘴潭人工湖設施位置圖

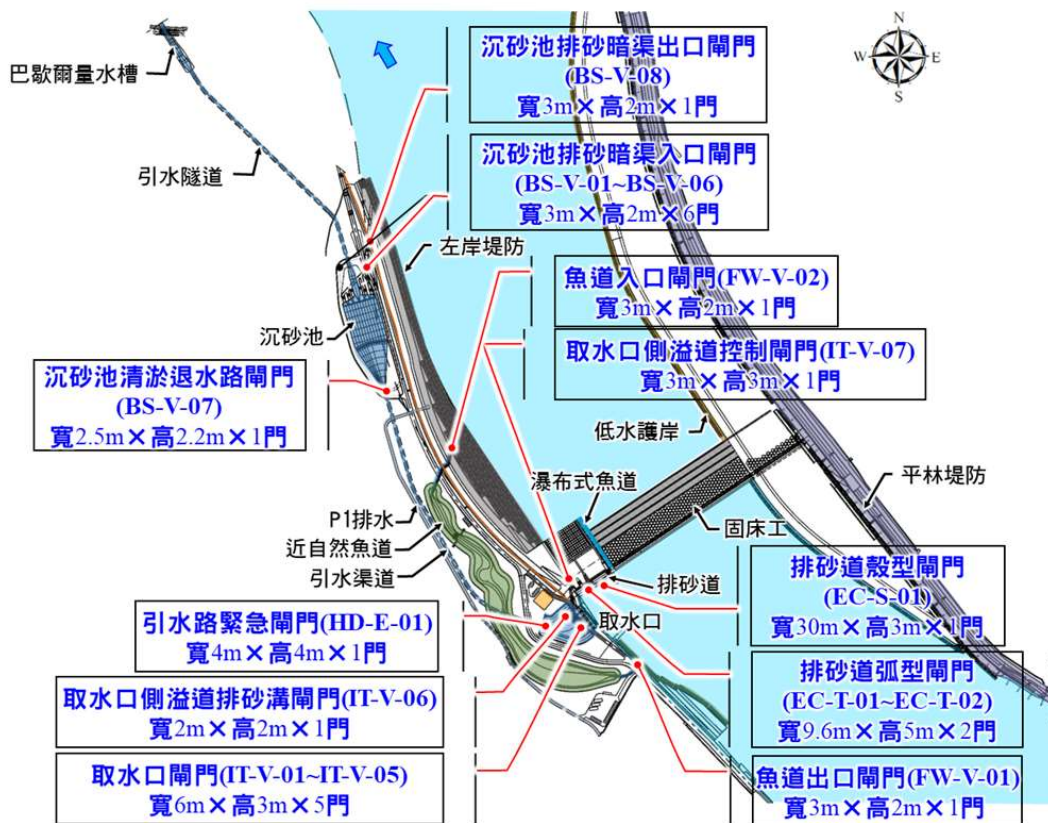

附圖二 引水設施閘門位置圖

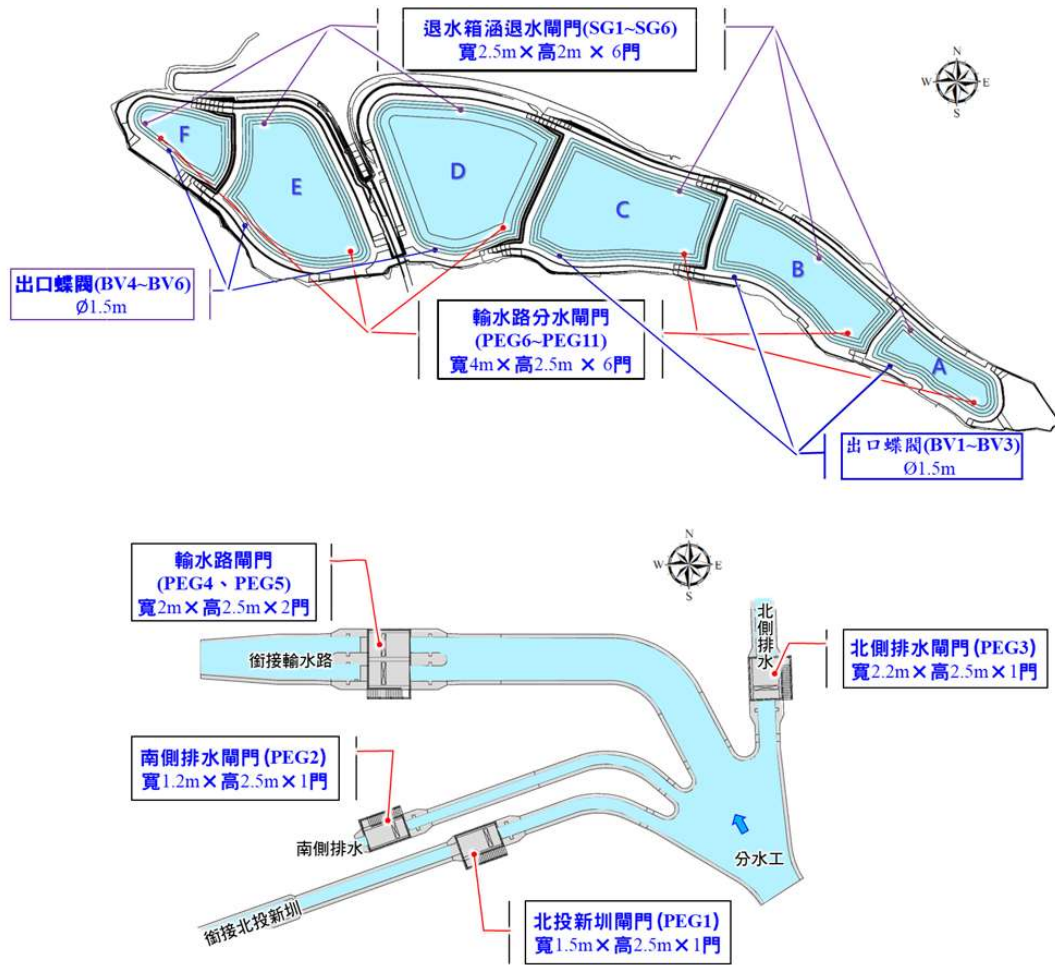

附圖三 人工湖區各設施閘門位置圖

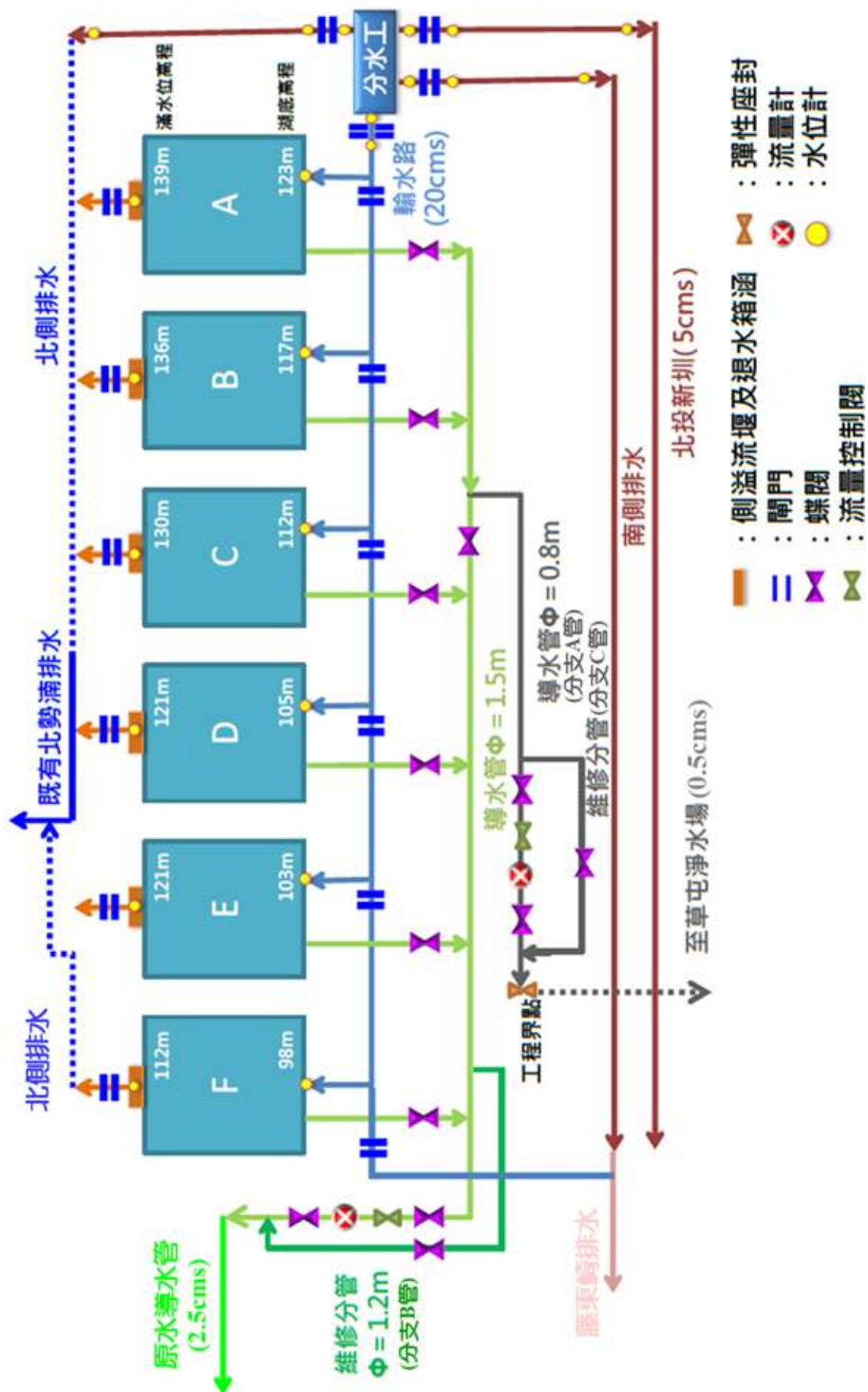

附圖四 人工湖區供水系統簡圖

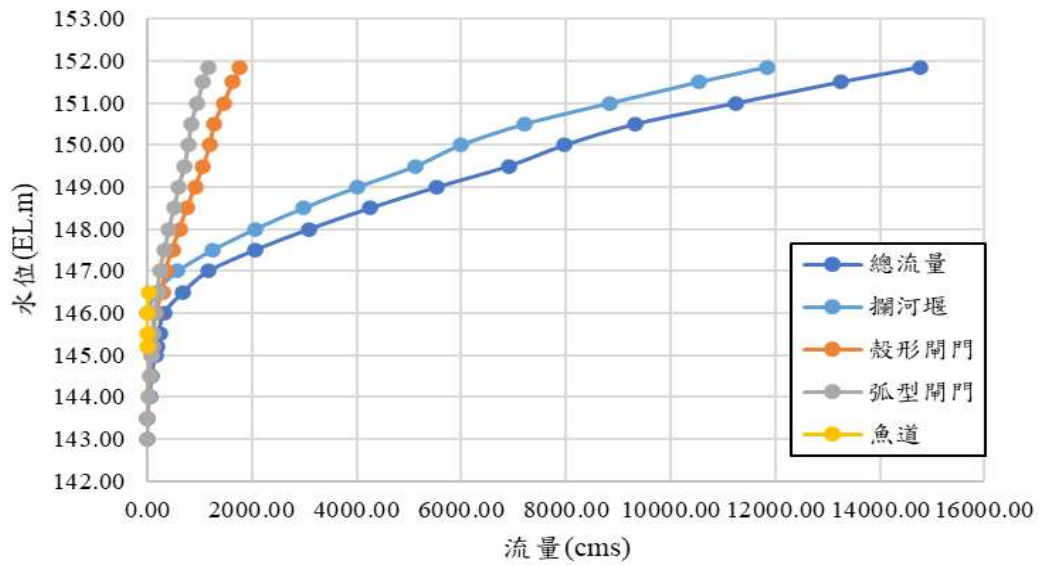

附圖五 固床工之流量率定曲線圖

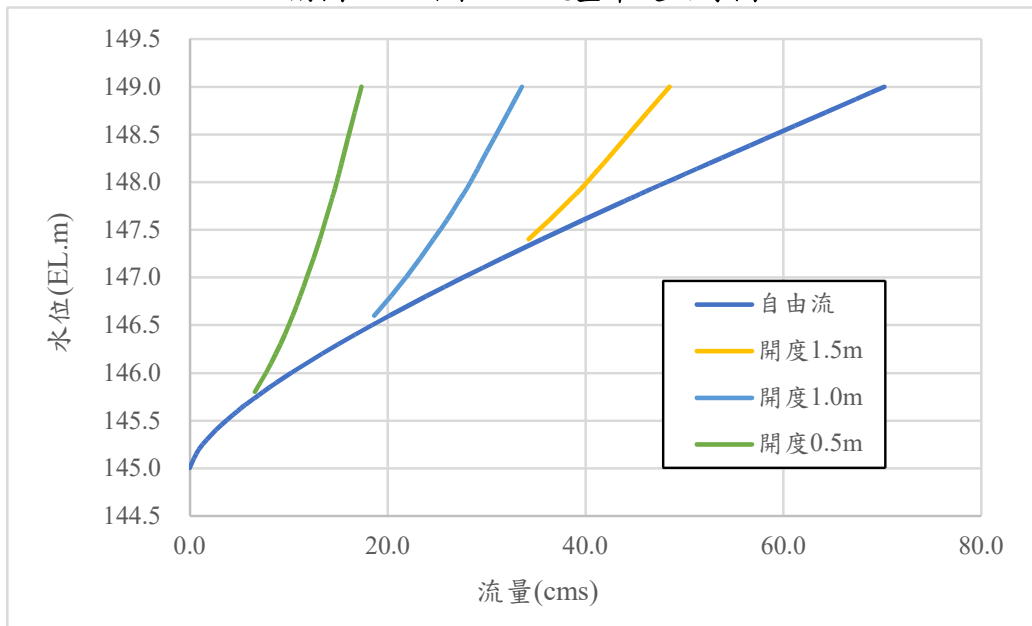

附圖六 取水口閘門(開啟一門)水位-開度-流量圖

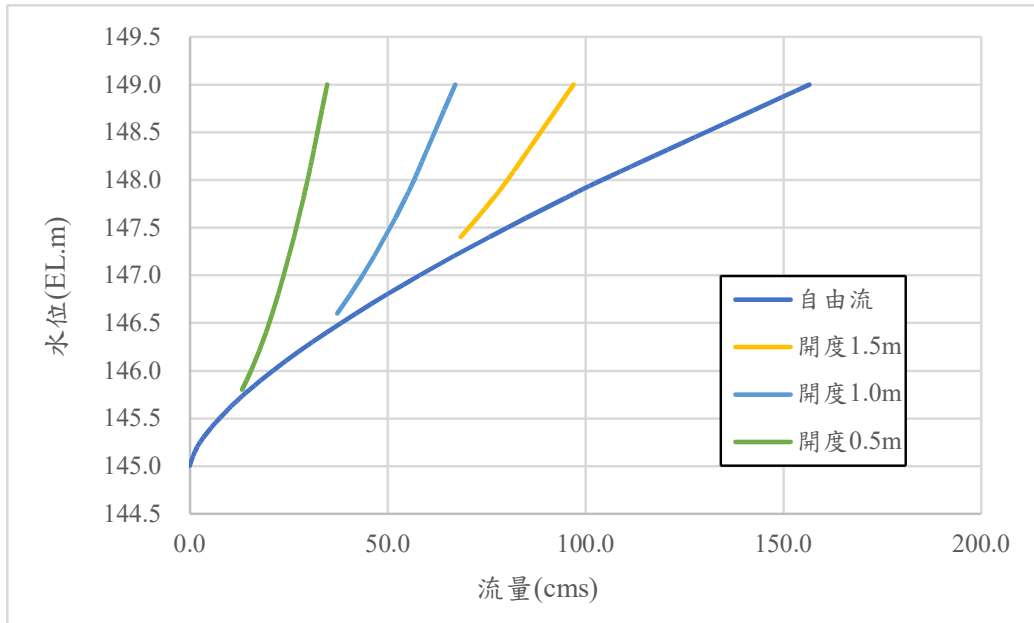

附圖七 取水口開門(開啟二門)水位-開度-流量圖

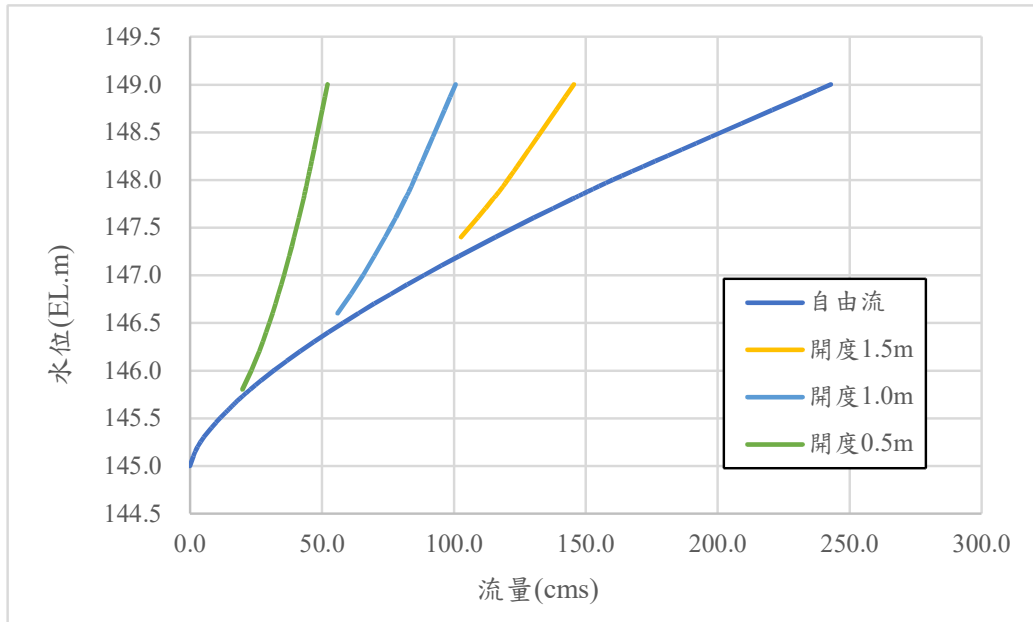

附圖八 取水口開門(開啟三門)水位-開度-流量圖

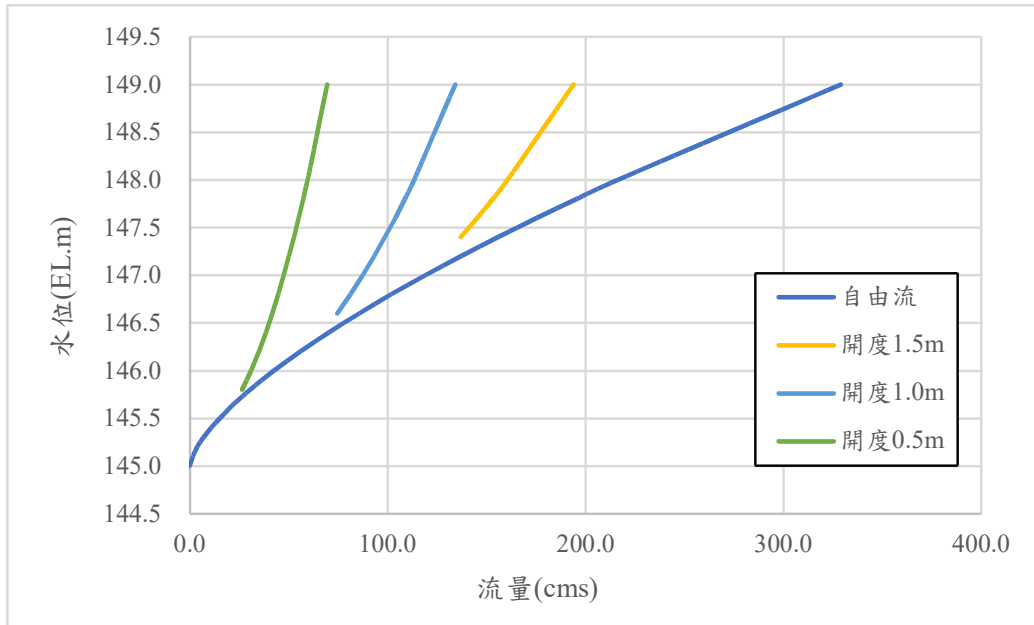

附圖九 取水口開門(開啟四門)水位-開度-流量圖

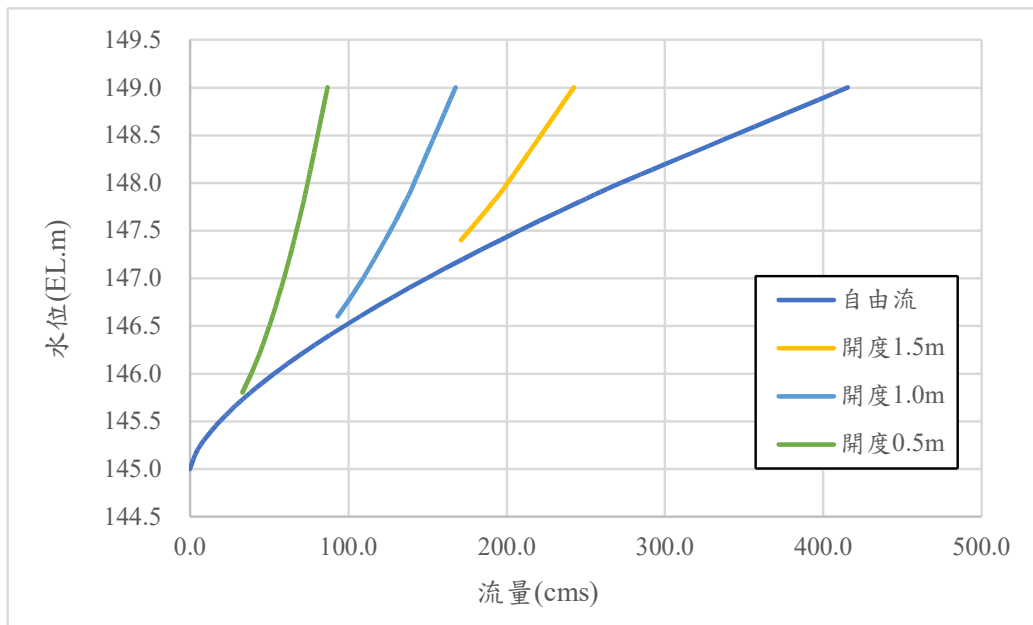

附圖十 取水口開門(開啟五門)水位-開度-流量圖

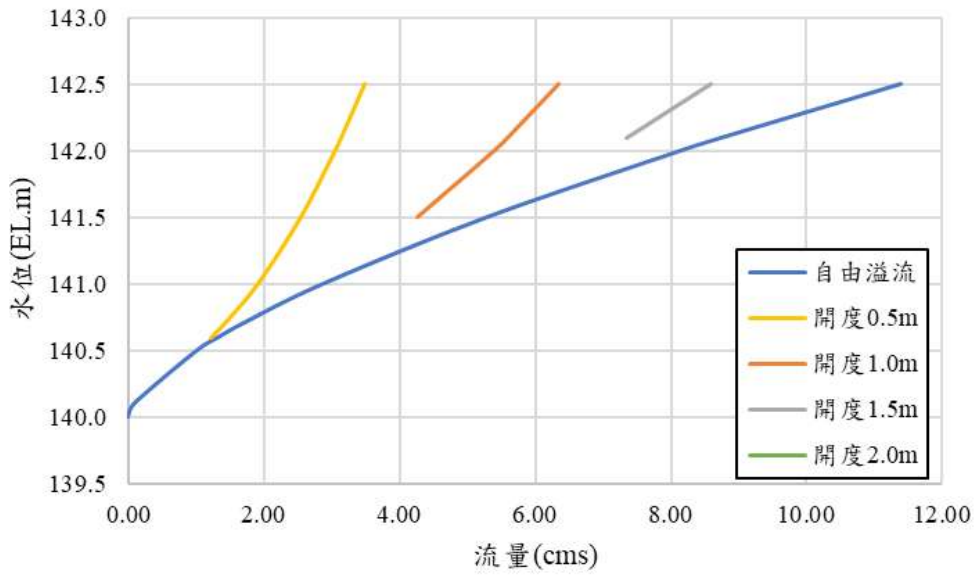

附圖十一 北投新圳閘門水位-開度-流量圖

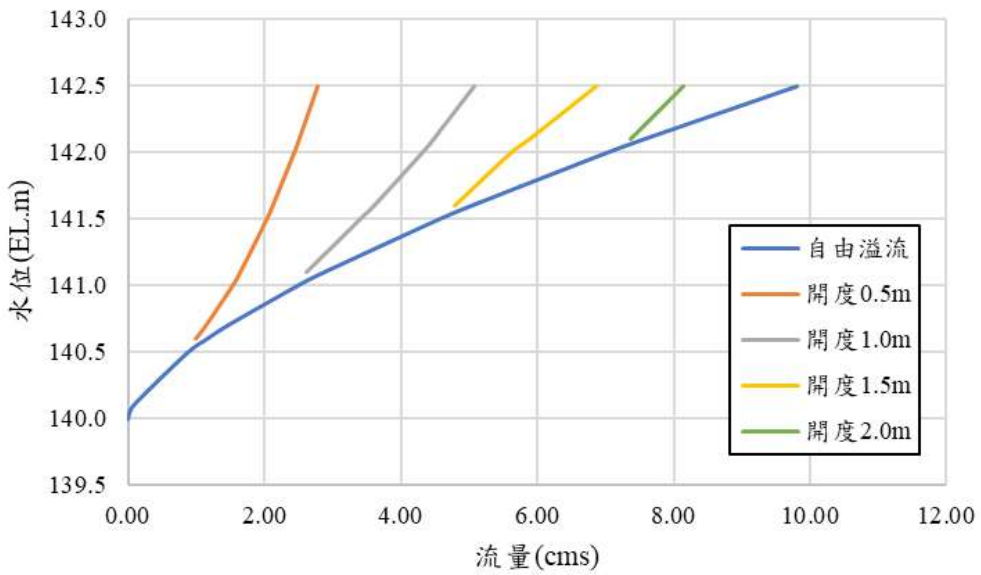

附圖十二 南側排水閘門水位-開度-流量圖

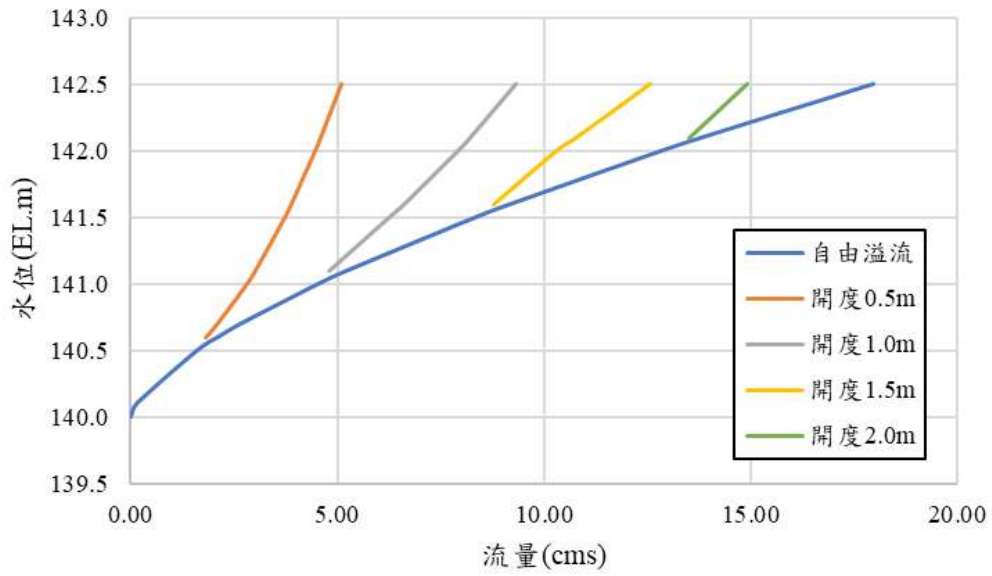

附圖十三 北側排水閘門水位-開度-流量圖

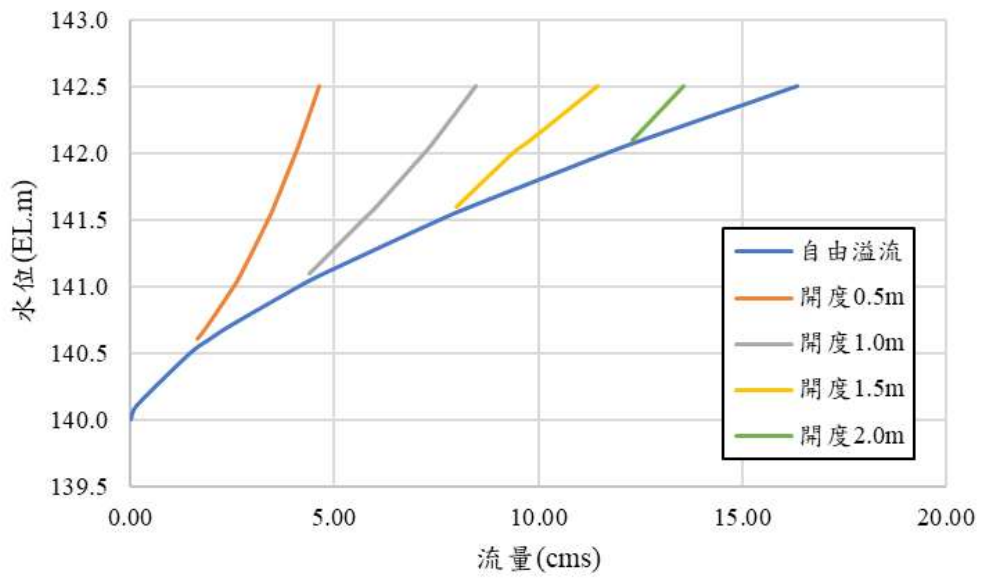

附圖十四 輸水路閘門(開啟一門)水位-開度-流量圖

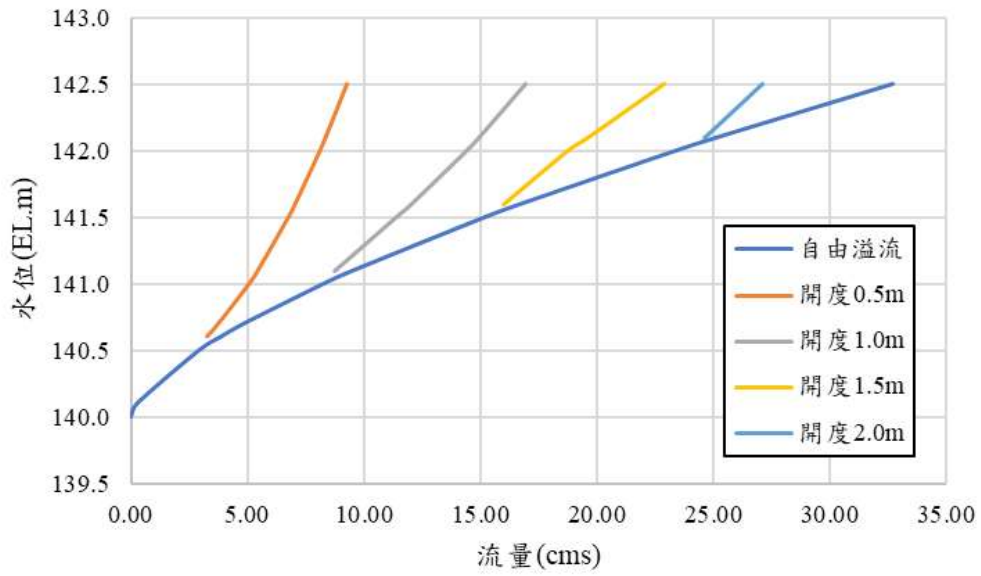

附圖十五 輸水路閘門(開啟二門)水位-開度-流量圖

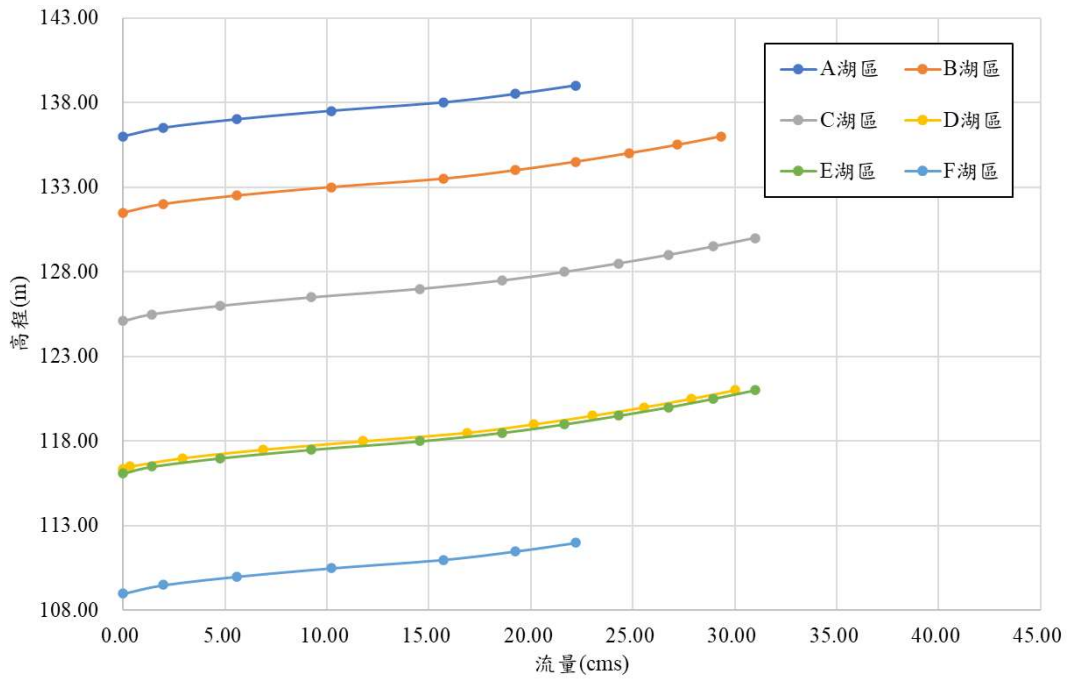

備註：溢流堰頂標高：A湖區：一百三十九公尺、B湖區：一百三十六公尺、
C湖區：一百三十公尺、D湖區：一百二十一公尺、
E湖區：一百二十一公尺、F湖區：一百一十二公尺。

附圖十六 各湖區退水箱涵流量率定曲線圖

附表一 固床工之水位與流量關係表

水位 (EL.m)	排砂道弧型開門 (EC-T-01、EC-T-02)	排砂道殼型開門 (EC-S-01)	瀑布式魚道	固定堰	總流量 (cms)
143.00	-	-	-	-	0.00
143.50	9.28	0.00	-	-	9.28
144.00	26.66	14.54	-	-	41.20
144.50	49.58	41.88	-	-	91.46
145.00	77.17	78.13	-	-	155.30
145.20	88.78	95.80	0.00	-	184.58
145.50	108.73	121.95	1.00	-	231.68
146.00	144.06	172.32	4.41	0.00	320.79
146.50	204.39	285.64	28.88	171.10	690.00
147.00	242.95	346.60	580.44		1,170.00
147.50	328.73	476.42	1,244.85		2,050.00
148.00	418.72	614.42	2,056.86		3,090.00
148.50	512.32	759.37	2,978.31		4,250.00
149.00	608.86	909.97	4,011.17		5,530.00
149.50	708.33	1,066.05	5,125.62		6,900.00
150.00	789.73	1,195.63	5,991.53		7,976.90
150.50	839.65	1,277.72	7,207.63		9,325.00
151.00	952.31	1,455.64	8,842.05		11,250.00
151.50	1,066.91	1,637.21	10,545.88		13,250.00
151.86	1,152.96	1,773.74	11,853.31		14,780.00

附表二 取水口開門(開啟一門)水位-開度-流量表

開度(m) 水位(EL.m)	0.5	1.0	1.5	2.0	2.5	自由流 (cms)
145.0						0.0
145.2						1.0
145.4						2.7
145.6						4.9
145.8						5.9
145.68	6.6					7.4
146.0	7.7					10.3
146.2	8.7					13.4
146.4	9.6					16.7
146.6	10.4	18.6				20.2
146.8	11.2	20.3				23.9
147.0	11.9	21.9				27.7
147.2	12.5	23.3				31.6
147.4	13.2	24.7	34.3			35.6
147.6	13.8	26.0	36.3			39.7
147.8	14.3	27.2	38.3			43.9
148.0	14.9	28.4	40.2			48.2
149.0	17.4	33.6	48.5	61.8	73.7	70.2

附表三 取水口開門(開啟二門)水位-開度-流量表

開度(m) 水位(EL.m)	0.5	1.0	1.5	2.0	2.5	自由流 (cms)
145.0						0.0
145.2						1.9
145.4						5.4
145.6						9.9
145.8						11.9
145.68	13.2					15.2
146.0	15.5					21.1
146.2	17.4					27.6
146.4	19.2					34.6
146.6	20.8	37.3				42.0
146.8	22.3	40.6				49.9
147.0	23.7	43.7				58.2
147.2	25.1	46.6				66.8
147.4	26.3	49.3	68.5			75.7
147.6	27.5	52.0	72.7			85.0
147.8	28.6	54.4	76.6			94.5
148.0	29.7	56.7	80.3			104.3
149.0	34.7	67.1	97.0	123.7	147.4	156.5

附表四 取水口閘門(開啟三門)水位-開度-流量表

開度(m) 水位(EL.m)	0.5	1.0	1.5	2.0	2.5	自由流 (cms)
145.0						0.0
145.2						2.9
145.4						8.1
145.6						14.9
145.8						18.0
145.68	19.8					22.9
146.0	23.2					31.9
146.2	26.2					41.8
146.4	28.9					52.5
146.6	31.3	55.9				63.9
146.8	33.5	61.0				76.0
147.0	35.6	65.6				88.7
147.2	37.6	69.9				102.0
147.4	39.5	74.0	102.8			115.9
147.6	41.3	78.0	109.0			130.2
147.8	43.0	81.6	114.9			145.1
148.0	44.6	85.1	120.5			160.4
149.0	52.1	100.7	145.5	185.5	221.1	242.8

附表五 取水口閘門(開啟四門)水位-開度-流量表

開度(m) 水位(EL.m)	0.5	1.0	1.5	2.0	2.5	自由流 (cms)
145.0						0.0
145.2						3.9
145.4						10.9
145.6						19.9
145.8						24.0
145.68	26.4					30.6
146.0	30.9					42.7
146.2	34.9					55.9
146.4	38.5					70.3
146.6	41.7	74.6				85.7
146.8	44.7	81.3				102.0
147.0	47.5	87.5				119.2
147.2	50.1	93.2				137.2
147.4	52.6	98.6	137.0			156.0
147.6	55.0	104.0	145.4			175.5
147.8	57.3	108.8	153.2			195.6
148.0	59.5	113.5	160.7			216.4
149.0	69.5	134.2	194.0	247.4	294.8	329.2

附表六 取水口閘門(開啟五門)之水位-開度-流量表

開度(m) 水位(EL.m)	0.5	1.0	1.5	2.0	2.5	自由流 (cms)
145.0						0.0
145.2						4.8
145.4						13.6
145.6						24.9
145.8						30.1
145.68	33.0					38.3
146.0	38.7					53.4
146.2	43.6					70.1
146.4	48.1					88.2
146.6	52.1	93.2				107.6
146.8	55.8	101.6				128.1
147.0	59.3	109.3				149.7
147.2	62.6	116.5				172.4
147.4	65.8	123.3	171.3			196.1
147.6	68.8	130.0	181.7			220.7
147.8	71.6	136.0	191.5			246.2
148.0	74.4	141.8	200.9			272.5
149.0	86.8	167.8	242.6	309.2	368.5	415.5

附表七 北投新圳閘門之水位-開度-流量表

流量：cms

開度(m) 水位(EL.m)	0.50	1.00	1.50	2.00	自由溢流
140.60	1.23	-	-	-	1.34
140.70	1.41	-	-	-	1.69
141.00	1.91	-	-	-	2.88
141.50	2.54	4.26	-	-	5.29
142.00	3.05	5.40	-	-	8.14
142.10	3.14	5.60	7.35	-	8.76
142.50	3.48	6.35	8.58	-	11.38

附表八 南側排水閘門之水位-開度-流量表

流量：cms

開度(m)	0.50	1.00	1.50	2.00	自由溢流
水位(EL.m)					
140.60	0.98	-	-	-	1.07
140.70	1.13	-	-	-	1.35
141.00	1.53	-	-	-	2.30
141.10	1.64	2.62	-	-	2.86
141.50	2.03	3.41	-	-	4.45
141.60	2.12	3.61	4.79	-	5.02
142.00	2.44	4.32	5.62	-	6.51
142.10	2.51	4.48	5.88	7.38	7.55
142.50	2.78	5.08	6.87	8.14	9.10

附表九 北側排水閘門之水位-開度-流量表

流量：cms

開度(m)	0.50	1.00	1.50	2.00	自由溢流
水位(EL.m)					
140.60	1.80	-	-	-	2.11
140.70	2.07	-	-	-	2.66
141.00	2.80	-	-	-	4.55
141.10	3.01	4.81	-	-	5.25
141.50	3.72	6.25	-	-	8.35
142.00	4.47	7.92	10.30	-	12.86
142.10	4.60	8.22	10.78	13.52	13.84
142.50	5.11	9.31	12.59	14.92	17.98

附表十 輸水路閘門之水位-開度-流量表(開啟一門)

流量：cms

開度(m)	0.50	1.00	1.50	2.00	自由溢流
水位(EL.m)					
140.60	1.64	-	-	-	1.92
140.70	1.89	-	-	-	2.42
141.00	2.55	-	-	-	4.13
141.10	2.73	4.37	-	-	4.77
141.50	3.39	5.68	-	-	7.59
141.60	3.53	6.02	7.98	-	8.37
142.00	4.06	7.20	9.36	-	11.69
142.10	4.18	7.47	9.80	12.29	12.58
142.50	4.64	8.47	11.44	13.56	16.34

附表十一 輸水路閘門之水位-開度-流量表(開啟二門)

流量：cms

開度(m)	0.50	1.00	1.50	2.00	自由溢流
水位(EL.m)					
140.60	3.27	-	-	-	3.84
140.70	3.77	-	-	-	4.84
141.00	5.09	-	-	-	8.27
141.10	5.47	8.75	-	-	9.54
141.50	6.77	11.37	-	-	15.19
141.60	7.06	12.03	15.96	-	16.73
142.00	8.12	14.40	18.72	-	23.39
142.10	8.37	14.94	19.60	24.59	25.16
142.50	9.28	16.93	22.89	27.12	32.68

附表十二 A至C湖區退水箱涵之水位-流量表

流量：cms

水位(EL.m)	A 湖區	B 湖區	C 湖區
125.10	-	-	0.00
125.50	-	-	1.40
126.00	-	-	4.75
126.50	-	-	9.21
127.00	-	-	14.54
127.50	-	-	18.60
128.00	-	-	21.65
128.50	-	-	24.30
129.00	-	-	26.75
129.50	-	-	28.95
130.00	-	-	31.00
131.50	-	0.00	-
132.00	-	1.96	-
132.50	-	5.55	-
133.00	-	10.20	-
133.50	-	15.70	-
134.00	-	19.25	-
134.50	-	22.20	-
135.00	-	24.80	-
135.50	-	27.20	-
136.00	0.00	29.35	-
136.50	1.96	-	-
137.00	5.55	-	-
137.50	10.20	-	-
138.00	15.70	-	-
138.50	19.25	-	-
139.00	22.20	-	-

附表十三 D至F湖區退水箱涵之水位-流量表

流量：cms

水位(EL.m)	D 湖區	E 湖區	F 湖區
109.00	-	-	0.00
109.50	-	-	1.96
110.00	-	-	5.55
110.50	-	-	10.20
111.00	-	-	15.70
111.50	-	-	19.25
112.00	-	-	22.20
116.10	-	0.00	-
116.35	0.00	0.69	-
116.50	0.32	1.40	-
117.00	2.91	4.75	-
117.50	6.84	9.21	-
118.00	11.76	14.54	-
118.50	16.85	18.60	-
119.00	20.15	21.65	-
119.50	23.00	24.30	-
120.00	25.55	26.75	-
120.50	27.85	28.95	-
121.00	30.00	31.00	-